

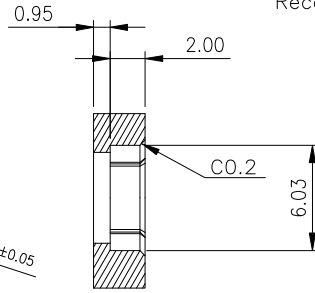

RoHS  
Compliant

Chassis panel

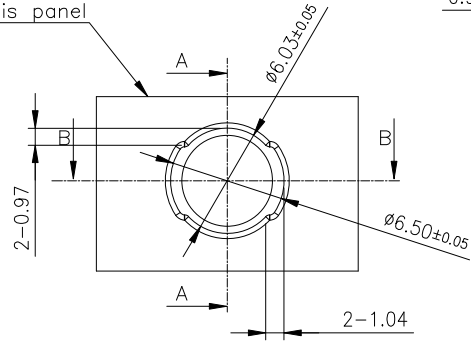

A-A SECTION

Recommended seal

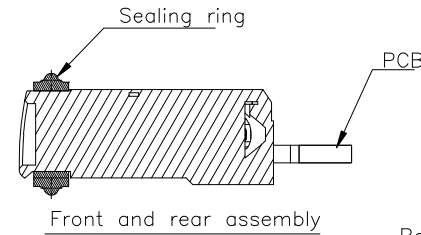

Front and rear assembly

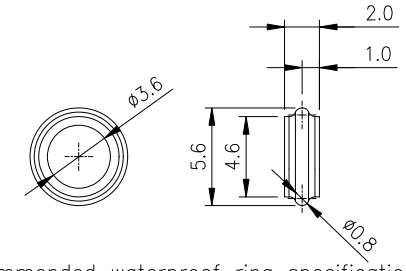

Recommended waterproof ring specifications  
(MATERIAL:Silicone 60A BLACK.)

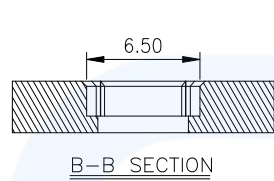

B-B SECTION

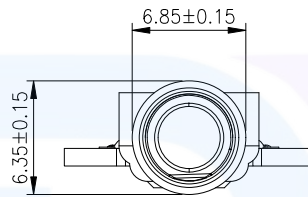

Dimensions after  
O-ring assembly

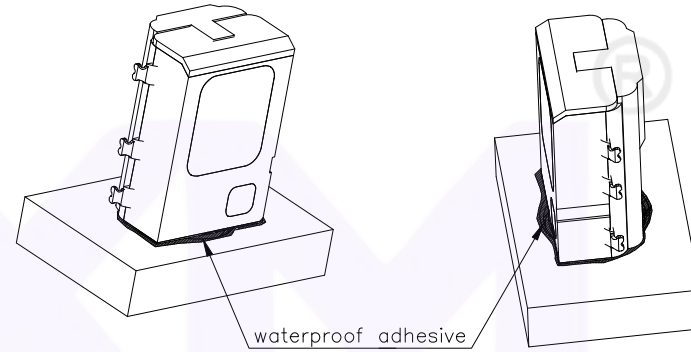

waterproof adhesive

After the finished product is inserted into the mechanism  
a circle of waterproof adhesive must be dotted around it

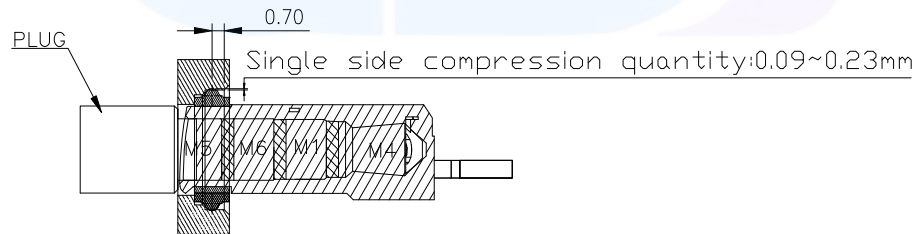

Schematic diagram of male  
and female head pointing



NOTE:

1. Rated Voltage: DC 6.0 V.
2. Rated Current: 1.8A
3. Service Temperature:  $-30^{\circ}\text{C} \sim +85^{\circ}\text{C}$ .
4. Protection IP Code: IP67 (Receptacle only, plug not included.)

广东小迈实业有限公司

Website:

<https://www.xmconn.com>

TEL:

18938295888



PART NAME

$\phi 3.5\text{mm}$  AUDIO JACK

PART NO.

DM35A002-06FP

TOLERANCE UNLESS  
OTHERWISE SPECIFIED:

X  $\pm 0.2$   
X.X  $\pm 0.15$   
X.XX  $\pm 0.10$   
X.XXX  $\pm 0.050$

DRAWING:

Li

DATE:

2023.08.18

CHECK:

Chen

DATE:

2023.08.18

APPROVAL:

Wen

DATE:

2023.08.18

SCALE

1:1

SHEET

2/3

REV: A0

SIZE: A4



RoHS  
Compliant

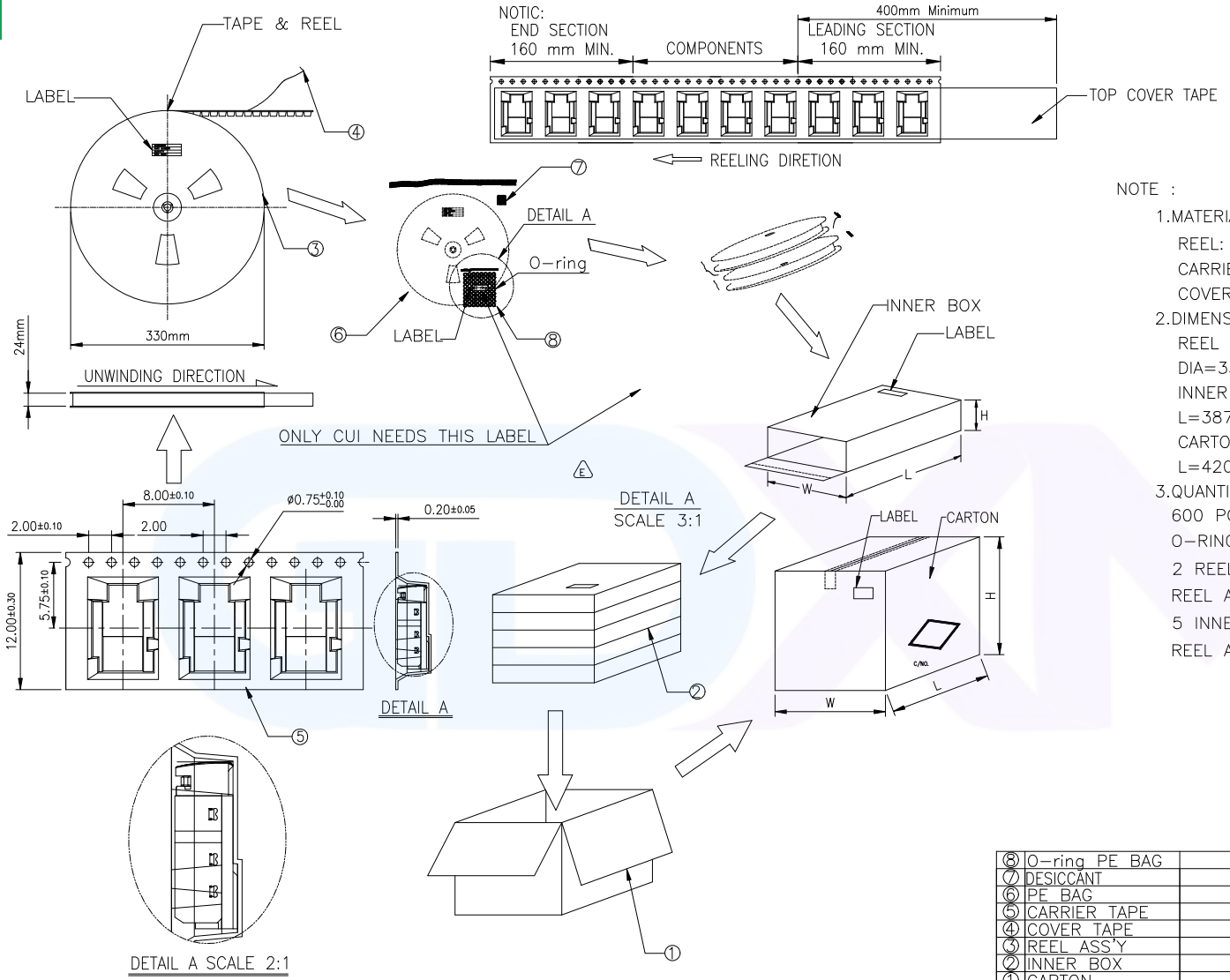

NOTE :

1.MATERIAL :  
 REEL: PS  
 CARRIER: PS  
 COVER TAPE: PET

2.DIMENSION :  
 REEL SIZE:  
 DIA=330.0mm, W=24.0mm  
 INNER BOX:  
 L=387mm, W=387mm H=67mm  
 CARTON:  
 L=420mm, W=406mm, H=380mm

3.QUANTITY:  
 600 PCS PRODUCTS/1 REEL AND 600PCS  
 O-RING/1 PE BAG  
 2 REEL/INNER BOX:1200PCS PRODUCTS/  
 REEL AND 1200PCS O-RING/2 PE BAG  
 5 INNER BOX/CARTON:6000PCS PRODUCTS/  
 REEL AND 6000PCS O-RING/10 PE BAG

⑧	O-ring PE BAG	PE		10	
⑦	DESICCANT			10	
⑥	PE BAG	PE	VACUUM SEAL	10	
⑤	CARRIER TAPE	PS		4	
④	COVER TAPE	PET		1	
③	REEL ASSY	PS		10	
②	INNER BOX	7+A		5	
①	CARTON	K=K		1	
ITEM	DESCRIPTIONs	MATERIAL	FINISH	Q'TY	NOTE

广东小迈实业有限公司

Website: <https://www.xmconn.com> TEL: 18938295888



PART NAME:  $\phi$ 3.5mm AUDIO JACK  
 PART NO.: DM35A002-06FP

TOLERANCE UNLESS OTHERWISE SPECIFIED:  
 X  $\pm$ 0.2  
 X.X  $\pm$ 0.15  
 X.XX  $\pm$ 0.10  
 X.XXX  $\pm$ 0.050

DRAWING: Li DATE: 2023.08.18 SCALE SHEET REV: A0  
 CHECK: Chen DATE: 2023.08.18 1:1 3/3 SIZE: A4  
 APPROVAL: Wen DATE: 2023.08.18