

RoHS
Compliant

ZONE	ECN . N.O .	DESCRIPTION	DRAWING	DATE
A		INITIAL	林生財	2024.04.15

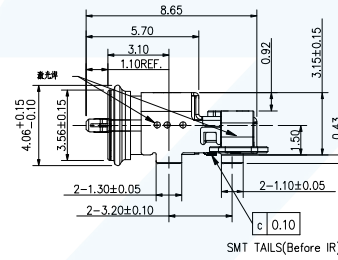

- NOTES:
- ELECTRICAL CHARACTERISTICS:
 - CONTACT CURRENT RATING: 5.0A FOR VBUS PIN AND ITS CORRESPONDING GND PIN.
 - CONTACT RESISTANCE: 30 MILLIOHMS MAX FOR VBUS AND GND CONTACTS. 40 MILLIOHMS MAX FOR ALL OTHER CONTACTS.
 - DIELECTRIC WITHSTANDING VOLTAGE: 100 VRMS AC MIN.
 - INSULATION RESISTANCE: 100 MEGOHMS MIN.
 - MECHANICAL CHARACTERISTICS:
 - CONNECTOR INSERTION FORCE: 5~20N. AT A MAXIMUM RATE OF 12.5MM PER MINUTE.
 - CONNECTOR EXTRACTION FORCE: 8~20N AT A MAXIMUM RATE OF 12.5MM PER MINUTE. 6~20N AFTER DURABILITY TEST.
 - DURABILITY: 10000 CYCLES.
 - OPERATING TEMPERATURE: -55°C TO +85°C.
 - SALT SPRAY: 48HOURS.
 - DIMENSIONS ARE IN MILLIMETERS, BRACKETED DIMENSIONS ARE INCHES EQUIVALENTS.
 - RECOMMENDED PROCESS: IR REFLOW 260°C, 3~5SECONDS.
 - THE CONNECTOR IS ROHS COMPLIANT AND HALOGEN FREE COMPLIAN.

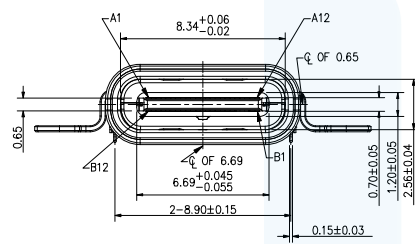
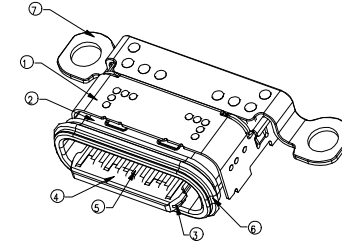
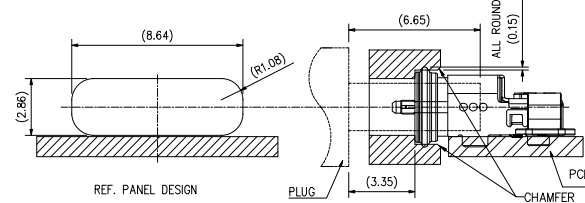
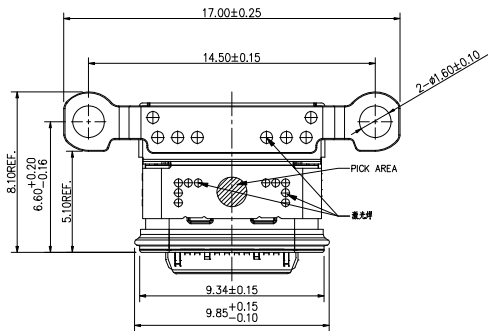
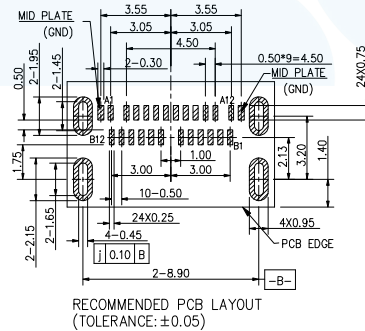
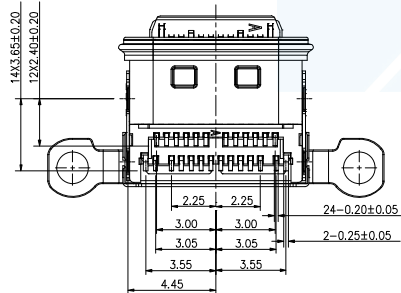

Pin	Signal Name	Pin	Signal Name
A1	GND	B12	GND
A2	SSTxp1	B11	SSRxp1
A3	SSTxn1	B10	SSRxn1
A4	Vbus	B9	Vbus
A5	CC1	B8	SBU2
A6	Dp1	B7	Dn2
A7	Dn1	B6	Dp2
A8	SBU1	B5	CC2
A9	Vbus	B4	Vbus
A10	SSRxn2	B3	SSTxn2
A11	SSRxp2	B2	SSTxp2
A12	GND	B1	GND

ITEM	PART NAME	Q'TY	Material&Plating
1	SUB-SHELL	1	SUS304 t=0.15, Ni PLATED 30u"
2	MAIN-SHELL	1	SUS316L t=0.20 CLEANING
3	LATCH	1	SUS301 t=0.15, Ni PLATED 30u"
4	HOUSING	1	PA9T+30%F, HF BLACK
5	CONTACT	24	C7025 t=0.12, Ni 50-150u" UNDER PLATED OVER.30u"Au PLATED ON THE CONTACT AREA, 3-8u"Au PLATED ON THE SOLDER TAILS.
6	LIM	1	CHN-LIMS-60A/B; Pull force 300g
7	COVER SHELL	1	SUS304 t=0.30 CLEANING

LZG® LZG INDUSTRIAL CO. LTD

PART NAME	USB TYPE C 防水母座 24PIN 高规格 SMT型 LIM注塑防水圈 镀镍芯片	TOLERANCE UNLESS	0.0±0.30	0.1±2'	UNIT: mm
PART NO.	ZB48093-24SBAP-A	OTHERWISE SPECIFIED:	0.00±0.20 0.000±0.10	0.0'±1' 0.00'±0.5'	

DRAWING:	林生財	DATE:	2024.04.15	SCALE	1:1
CHECK:	李宏鑫	DATE:	2024.04.15	MATERIAL	*
APPROVAL:	杨进宝	DATE:	2024.04.15	DWG. NO.	
DRAWING NO.	ZB48093-24SBAP-A			SHEET	1/1

RoHS
Compliant

ZONE	EC.N.O.	DESCRIPTION	DRAWING	DATE
A		INITIAL	林生财	2020.02.18

ITEM	W	A0	B0	D	E	F	K0	P0	P2	P	T
DIM	32.0	9.70	17.70	1.5	1.75	14.20	4.50	4.0	2.0	16.0	0.40
TOLE	+0.3 -0.3	+0.15 -0.15	+0.15 -0.15	+0.1 -0.0	±0.1	±0.10	+0.15 -0.15	±0.1	±0.1	±0.1	±0.05

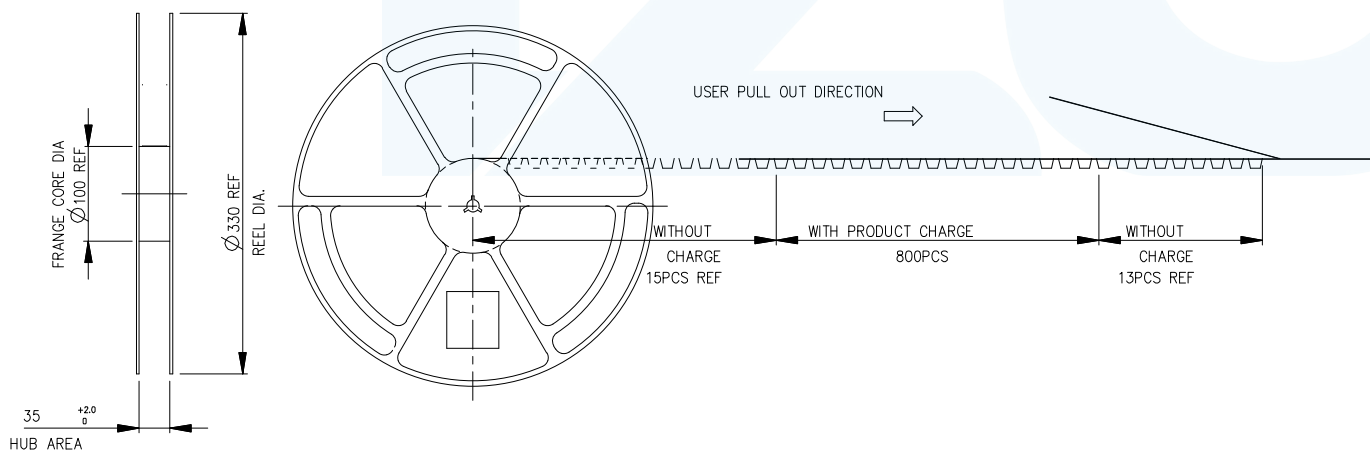
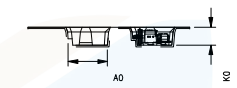
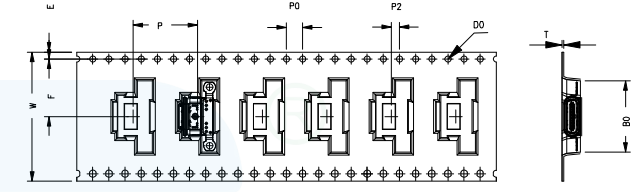
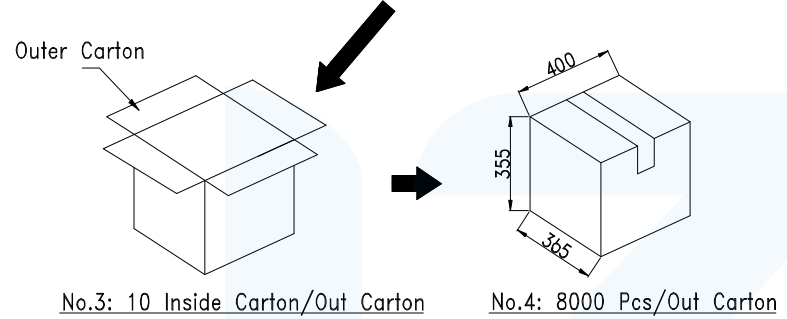
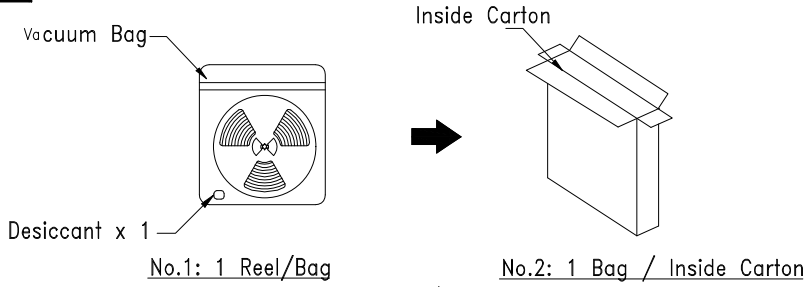

- 包装说明:
1. 将产品放入REEL卷中, 然后贴上透明PE上等800PCS/卷;
 2. 然后尾部用胶纸粘贴, 在REEL卷盘上贴上数量标签;
 3. 将包装好的产品放入指定的外箱中, 一箱装10盘8000 PCS/箱;
 4. 出货标签要严格按照要求进行填写;
 5. 纸箱封盖后以封箱胶封箱, 贴上出货标签;
 6. 外箱若客户另有贴标签要求, 则按其订单注明之要求贴;
 7. 纸箱尺寸及印刷见包材图画;
 8. 未滿之零数需用缓冲材料填满, 并贴上零数标签, 写明具体数量;
 9. 本包装适用产品: USB TYPE C母座24P 及排SMT 防水型;
 10. ROHS+HF.



LZG INDUSTRIAL CO. LTD

PART NAME	WATERPROOF TYPE C 24 PIN	TOLERANCE UNLESS	0.0±0.3	0.1*2"	UNIT: mm	APPROVAL:	林生财	DATE:	2020.02.18	SCALE:	1:1
PART NO.	ZB48093-24SBAP-A	OTHERWISE SPECIFIED:	0.00±0.2 0.000±0.1	0.0'±1" 0.00'±0.5"							

DRAWING NO.	ZB48093-24SBAP-A	DWG. NO.	
SHEET	1/1		