

RoHS
Compliant

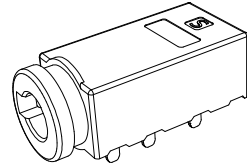

3D VIEW

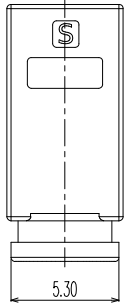
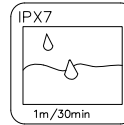

ZONE	ECN . N.O.	DESCRIPTION	DRAWING	DATE
A		INITIAL	林生財	2020.02.18

NOTES

- CURRENT RATING: 1A.
- CONTACT RESISTANCE: 100mΩ MAX.
- INSULATION RESISTANCE: 100MΩ MIN.
- DIELECTRIC WITHSTANDING: 500V AC MIN.
- DURABILITY: 5000 CYCLES MIN.
- CONNECTOR MATING FORCES: 3~30N.
- CONNECTOR UNMATING FORCES: 3~30N.
- OPERATING TEMPERATURE: -25°C TO +85°C.
- WATERPROOF LEVEL: IP67

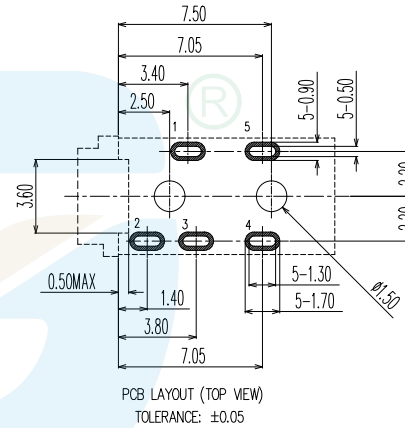
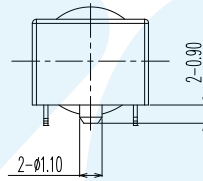
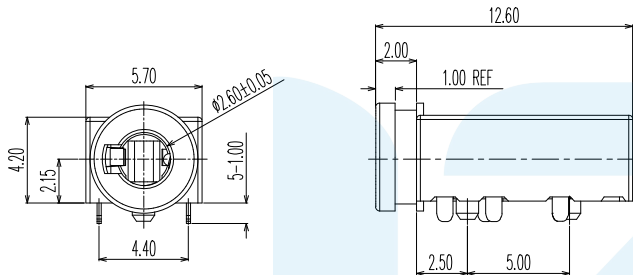

PCB LAYOUT (TOP VIEW)
TOLERANCE: ±0.05

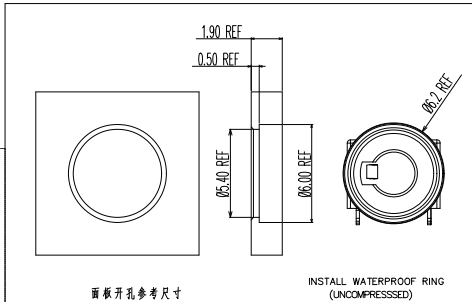
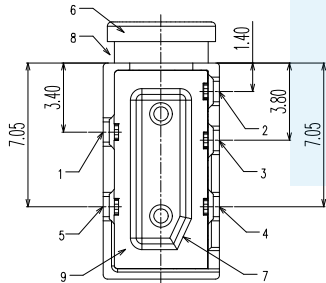

面板开孔参考尺寸

INSTALL WATERPROOF RING (UNCOMPRESSED)

Not to install the waterproof ring shipment

9	GLUE	EPOXY	COLOR BLACK	1
8	WATERPROOF RING	SILICONE	COLOR BLACK	1
7	COVER	HIGH TEMPERATURE	COLOR BLACK	1
6	HOUSING	HIGH TEMPERATURE	COLOR BLACK	1
5	TERMINAL 5#	STAINLESS STEEL	NICKEL UNDERPLATING OVERALL, GOLD FLASH PLATING ON THE SOLDER & CONTACT AREA	1
4	TERMINAL 4#	STAINLESS STEEL	NICKEL UNDERPLATING OVERALL, GOLD FLASH PLATING ON THE SOLDER & CONTACT AREA	1
3	TERMINAL 3#	PHOSPHOR BRONZE	NICKEL UNDERPLATING OVERALL, GOLD FLASH PLATING ON THE SOLDER & CONTACT AREA	1
2	TERMINAL 2#	PHOSPHOR BRONZE	NICKEL UNDERPLATING OVERALL, GOLD FLASH PLATING ON THE SOLDER & CONTACT AREA	1
1	TERMINAL 1#	STAINLESS STEEL	NICKEL UNDERPLATING OVERALL, GOLD FLASH PLATING ON THE SOLDER & CONTACT AREA	1
NO.	DESCRIPTION	MATERIAL	REMARKS	QTY

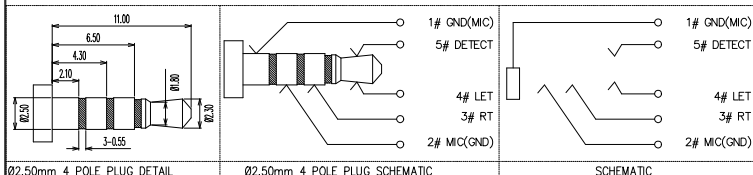

02.50mm 4 POLE PLUG DETAIL 02.50mm 4 POLE PLUG SCHEMATIC SCHEMATIC



LZG INDUSTRIAL CO. LTD

PART NAME	WATERPROOF Ø2.5 PHONE JACK	TOLERANCE UNLESS	0.0±0.25	0.°±2°	UNIT: mm
PART NO.	ZB20004-05DBAP-A	OTHERWISE SPECIFIED:	0.00±0.20 0.000±0.10	0.0°±1° 0.00°±0.5°	

DRAWING:	林生財	DATE:	2020.02.18	SCALE	1:1
CHECK:	李宏鑫	DATE:	2020.02.18	MATERIAL	*
APPROVAL:	楊建宏	DATE:	2020.02.18	DWG. NO.	
DRAWING NO.	ZB20004-05DBAP-A			SHEET	1/1