

RoHS
Compliant

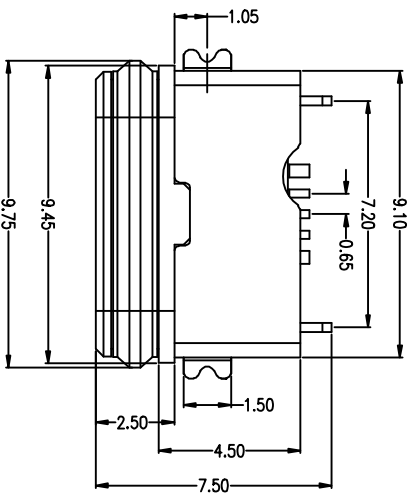

3D VIEW

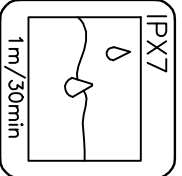
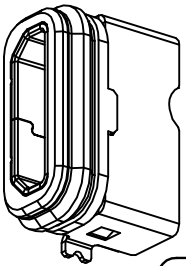

SPECIFICATIONS:

- 1 Current rating: 1.5PIN 2.0A Max/2,3,4PIN 1A Max.
- 2 Dielectric withstanding voltage: 100 V(ac) for 1 min.
- 3 Contact resistance: 30 mΩ Max.
- 4 Insulation resistance: 100 MΩ Min.
- 5 Total mating force: 3.57 Kgf Max.
- 6 Total unmating force: 1.0 Kgf Min.
- 7 Temperature range: -30°C~80°C
- 8 Waterproof: IPX7.

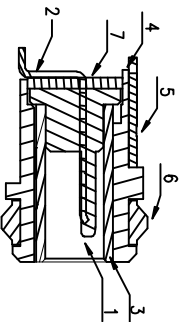
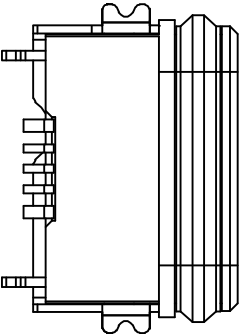
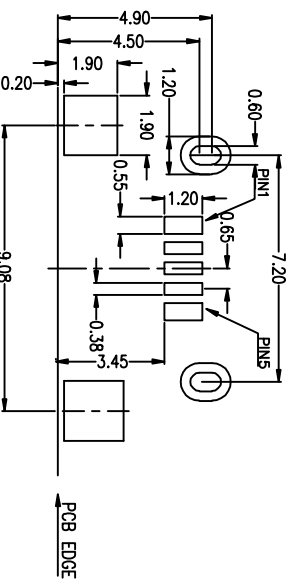
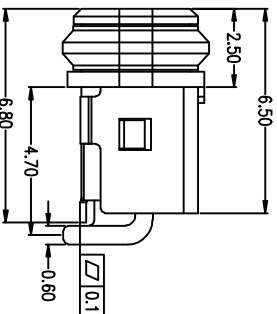
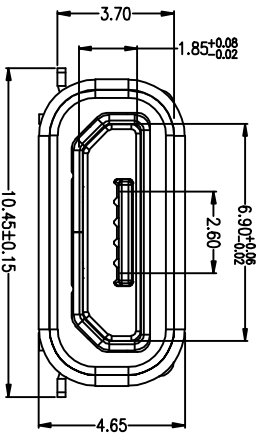

NO.	DESCRIPTION	MATERIAL	REMARKS	QTY
7	GLUE	EPOXY		1
6	RING	SILICON	COLOR BLACK	1
5	OUT SHELL	STAINLESS STEEL 0.2#	GOLD PLATING OVERALL	1
4	COVER	HIGH TEMPERATURE PLASTIC	COLOR BLACK	1
3	SHELL	STAINLESS STEEL 0.3#	GOLD PLATING OVERALL	1
2	CONTACT	COPPER ALLOY 0.2#	GOLD PLATING OVERALL	5
1	HOUSING	HIGH TEMPERATURE PLASTIC	COLOR BLACK	1



LZG INDUSTRIAL CO., LTD

PART NAME WATERPROOF MICRO USB SP B TYPE
PART NO. ZB43007-06SBAP-A

TOLERANCE UNLESS OTHERWISE SPECIFIED:

0.0±0.3
0.00±0.2
0.000±0.1

0.±2°
0.0°±1°
0.00°±0.5°

UNIT: mm

DRAWING: CHECK: 林生輝 日期: 2020.02.18

APPROVAL: 鄒建堂 日期: 2020.02.18

DRAWING NO. ZB43007-06SBAP-A

SCALE 1:1

MATERIAL *
DWG. NO.
SHEET 1/1

F

E

D

C

B

A

4

3

2

1

F

E

D

C

B

A

4

3

2

1