

RoHS  
Compliant

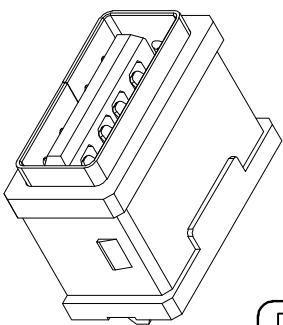

3D VIEW

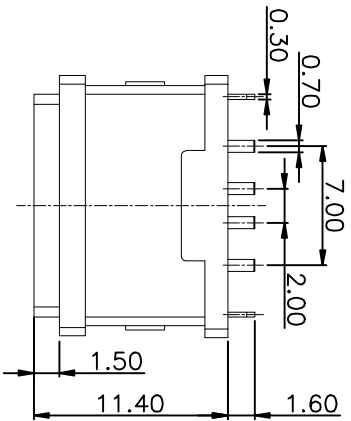
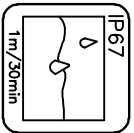

NOTES:

- SPECIFICATION:
1. CURRENT RATING: 3.0A MAX
  2. DIELECTRIC WITHSTAND VOLTAGE: 100VAC
  3. TEMPERATURE RANGE: -30 °C ~ 85 °C
  4. CONTACT RESISTANCE: 40 MILLIONHM MAX
  5. INSULATION RESISTANCE: 100 MEGOHMS MIN.
  6. INSERTION FORCE :10N~30N
  7. UNMATING FORCE: 8N~30N
  8. DURABILITY:1500 CYCLES

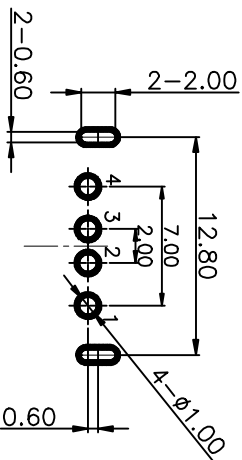
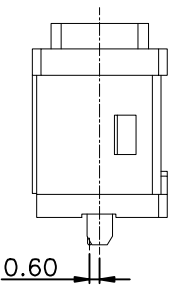
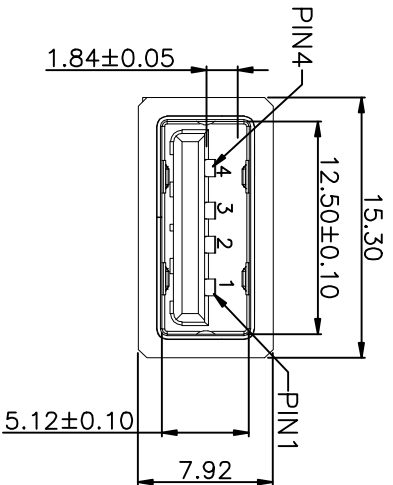

RECOMMENDED PCB LAYOUT(TOP VIEW)

THICKNESS T=1.0mm  
DEFAULT TOLERANCE+/-0.05

结构设计注意:  
1. 成品使用时, 如有洗面奶泡沫、牙膏、洗手液、脏污液体, 请在TYPE-C口外面再设计一层外壳, 保护TYPE-C表面金手指不会被脏污覆盖。

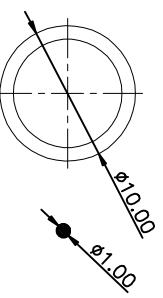
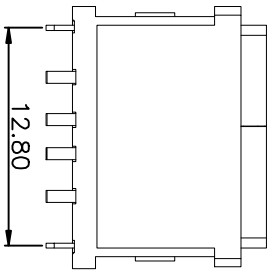

注: 防水圈厚度为0.5mm, 直径为1.0mm的圆孔, 防水圈厚度为0.5mm, 直径为1.0mm的圆孔。

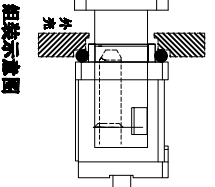

NO.	DESCRIPTION	MATERIAL	REMARKS	PIN ASSIGNMENT			
				PIN NO.	1	2	3
4	INNER SHELL	SUS 301	WASH	1	2	3	4
3	PLASTIC SHELL	PA10T	COLOR BLACK				
2	CONTACT	BRASS	Au/Ni Plating T=0.25mm				
1	HOUSING	PA10T	COLOR BLACK				

**LZG INDUSTRIAL CO., LTD**

PART NAME WATERPROOF USB 2.0 A TYPE  
PART NO. ZB40004-06DBAP-A

TOLERANCE UNLESS OTHERWISE SPECIFIED: 0.00±0.05

0.0±0.3  
0.00±0.1  
0.0°±1'  
0.00°±0.5'

UNIT: mm  
DRAWING NO. ZB40004-06DBAP-A

APPROVAL: 林生财  
CHECK: 李宏鑫

DATE: 2020.02.18  
DATE: 2020.02.18

F

E

D

C

B

A

4

3

2

1

4

3

2

1