

RoHS
Compliant

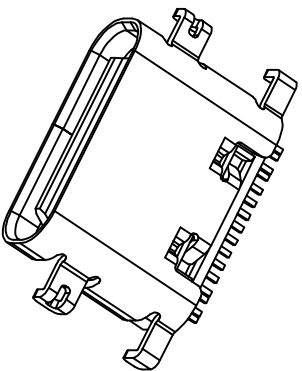

3D VIEW

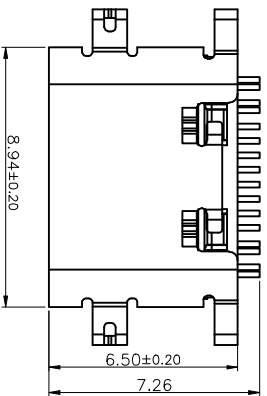
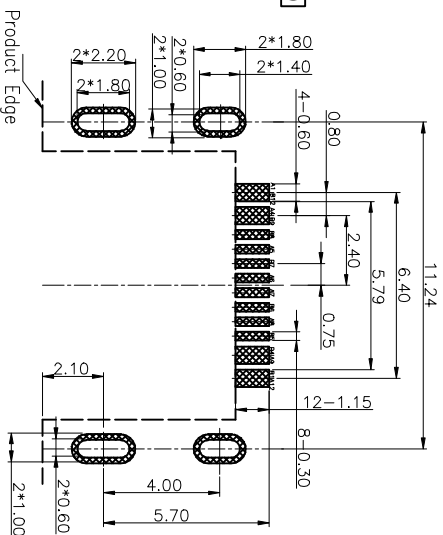
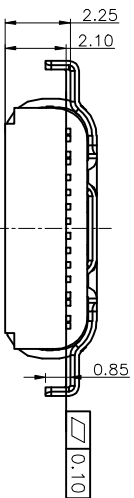
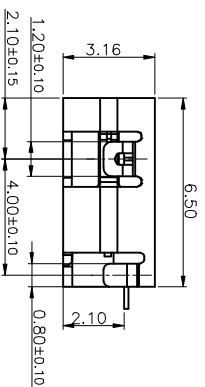
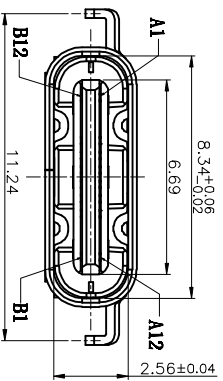

RECOMMENDED P.C.B. LAYOUT
TOLERANCE UNSPECIFIED ±0.05mm

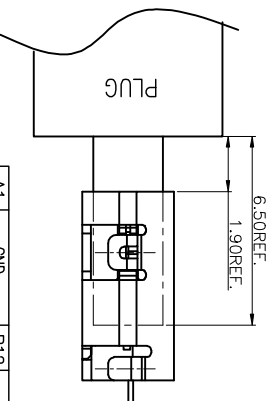
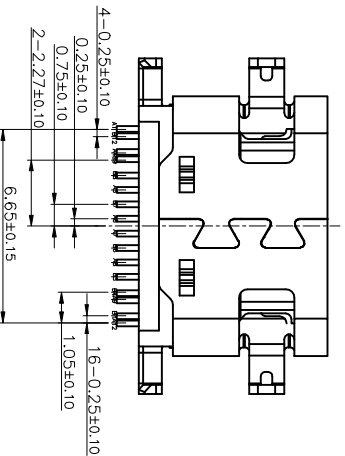

PIN	SIGNAL NAME	PIN	SIGNAL NAME	NO.	DESCRIPTION	MATERIAL	REMARKS	QTY
A1	GND	B12	GND	6	SHELL	STAINLESS STEEL	Ni Plated	1
A4	VBUS	B9	VBUS	5	SHIELDING PLATE	STAINLESS STEEL	---	1
A5	CC1	B8	SRU2	4	MD	HIGH TEMPERATURE PLASTIC	COLOR BLACK	1
A6	DP1	B7	DN2	3	CONTACT	COPPER ALLOY	Au/NI Plated	8
A7	DN1	B6	DP2	2	CONTACT	COPPER ALLOY	Au/NI Plated	8
A8	SRU1	B5	CC2	2	CONTACT	COPPER ALLOY	Au/NI Plated	8
A9	VBUS	B4	VBUS	1	HOUSING	HIGH TEMPERATURE PLASTIC	COLOR BLACK	1
A12	GND	B1	GND	1	HOUSING	HIGH TEMPERATURE PLASTIC	COLOR BLACK	1

LZG INDUSTRIAL CO., LTD

PART NAME: USB TYPE C 16PIN
PART NO.: ZB48041-16FBAP-A

TOLERANCE UNLESS SPECIFIED: 0.00±0.15
OTHERWISE SPECIFIED: 0.000±0.05

0.0±0.20
0.00±0.15

0.±1
0.0±1

UNIT: mm



DRAWING: 林生财
CHECK: 李宏鑫
APPROVAL: 杨进宝

DATE: 2020.02.18
DATE: 2020.02.18
DATE: 2020.02.18

DWG. NO. ZB48041-16FBAP-A

SHEET 1/1

ZONE	EC N. NO.	DESCRIPTION	DRAWING	DATE
A		INITIAL	林生财	2020.02.18